

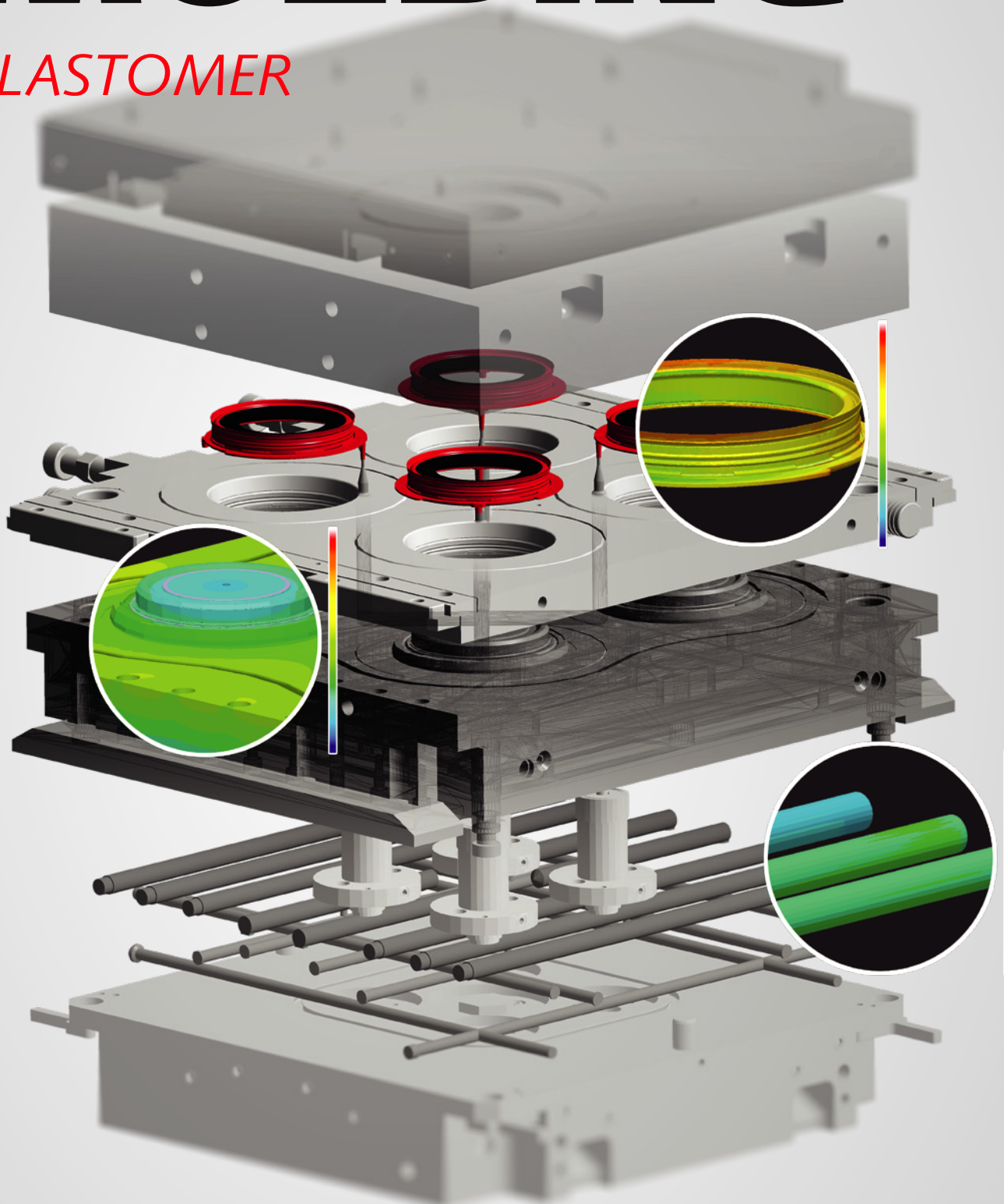

VIRTUAL MOLDING

ELASTOMER



SIGMASOFT[®]
Virtual Molding

Your 360° 3D simulation solution for high efficiency in the production of injection molded, elastomeric parts and polymer products.

SIGMASOFT® VIRTUAL MOLDING ELASTOMER

Just imagine you could analyze all parameters of your injection molding process, before the first prototype of your mold is built. An entirely virtualized production process, on top of that enriched with special know-how for elastomer processing. The perfect solution to visualize, analyze and optimize your mold concept, the material flow, use of energy during production and a number of further parameters. A virtual injection machine which can make the difference in profitability for your elastomer injection molding production. This imagination can become reality: with SIGMASOFT® VIRTUAL MOLDING Elastomer.

Besides the simulation of filling and curing behavior, SIGMASOFT® VIRTUAL MOLDING Elastomer is the only software solution which allows you to effortlessly simulate the whole mold as well as different tempering concepts, process times and inserts. The highly developed 3D technology enables you to virtually display complex rheological behavior – such as jetting, plug-flow and gravitational effects – in every detail. SIGMASOFT® VIRTUAL MOLDING Elastomer even depicts the polymer flow and curing reaction of thick-walled parts – with the help of realistic process parameters. For example by calculating several consecutive production cycles or simulating electrical heating. Here material, power and type of control system are fully taken into account.

With SIGMASOFT® VIRTUAL MOLDING Elastomer you optimize your injection molding processes in every detail. And find the actually most efficient solution.

SIGMASOFT® Elastomer answers the following questions:

- **Where is the ideal position for heating cartridges?**
- **How many heating cartridges should be used?**
- **Which power is necessary for each of them?**
- **Is it possible to reduce the heating time?**
- **Are there cold spots inside the mold?**
- **Is there an effective insulation between cold runner and hot mold?**
- **Where are the ideal positions for temperature sensors?**

Analysis included:

**Our engineers are there for you
SOLUTION SERVICE for SIGMASOFT® Users**

Almost three decades of plastic and injection molding know-how are contained in each one of our SIGMASOFT® VIRTUAL MOLDING solutions. Each analysis result from our software delivers reliable advice for the design of the optimal mold and process. To use the complete potential from SIGMASOFT® VIRTUAL MOLDING, the user has the SOLUTION SERVICE at hand – a team of engineers and technicians with profound experience in processes, materials and modelling. Additionally our Solution Service offers you competent support when setting up a project, as well as in the evaluation and analysis of the different results.

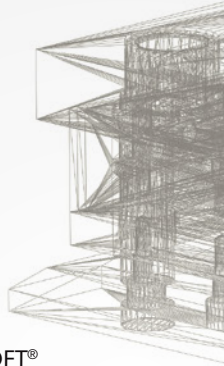
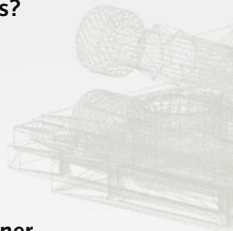

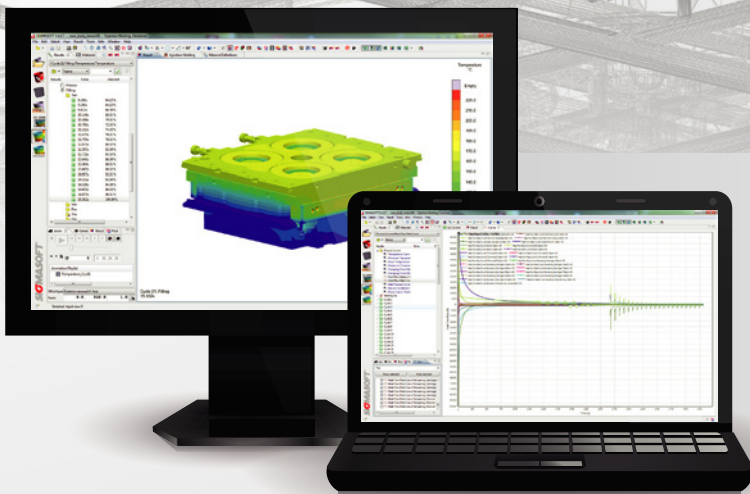
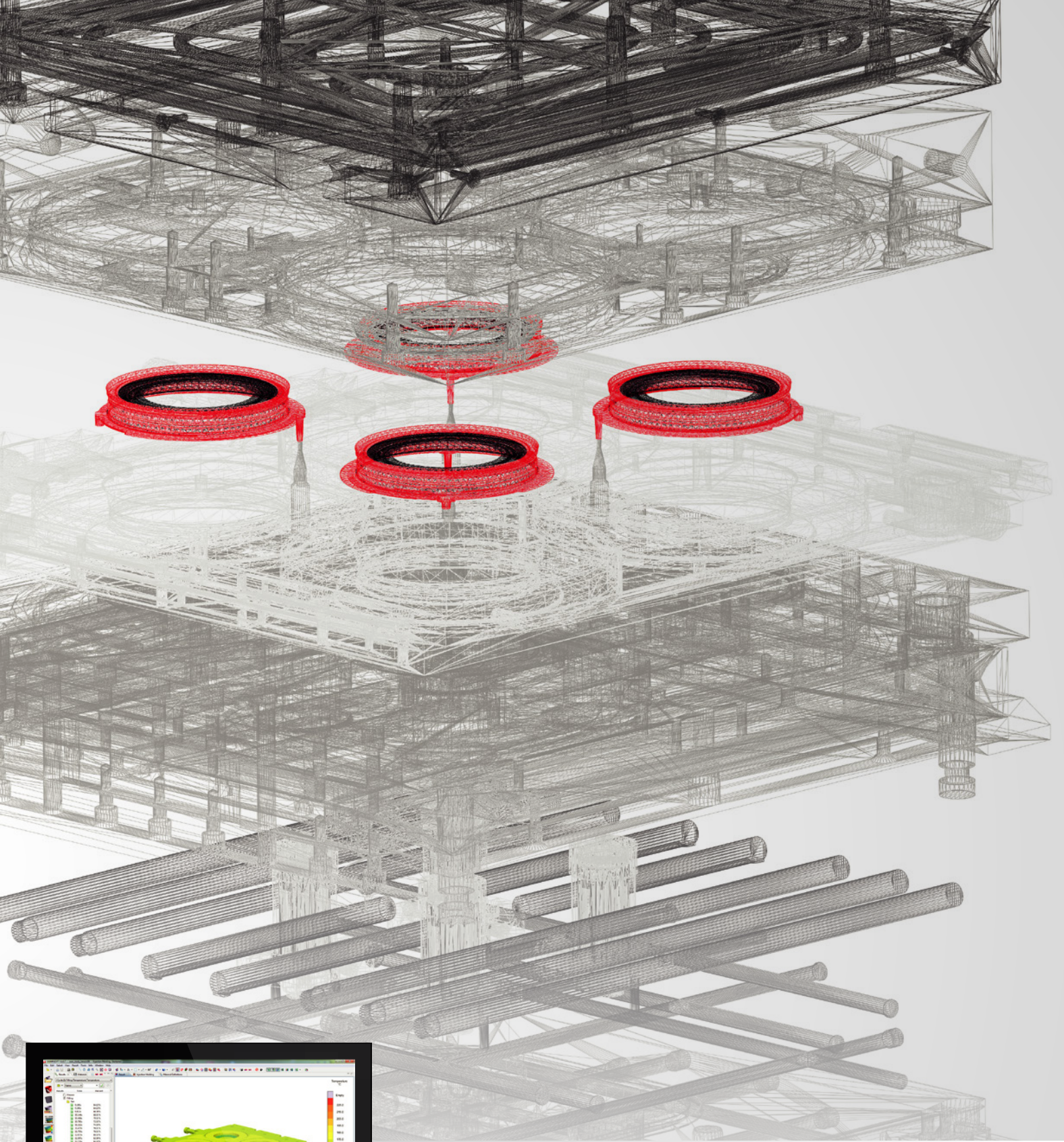

The intuitive, graphical user interface of SIGMASOFT® leads you step-by-step through all process levels. Automatic algorithms allow you to mesh a complete mold in a few minutes. Without need for mesh healing, triangle manipulation or removal of rounded or chamfered corners. SIGMASOFT® VIRTUAL MOLDING Elastomer makes the mold and process transparent during production.

SIGMASOFT® VIRTUAL MOLDING ELASTOMER

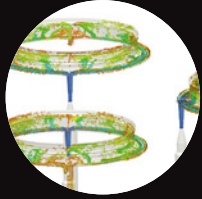

Exactly predicts part filling ...

... because the advanced modelling also considers extensional viscosities, thixotropy effects and pressure induced heating.

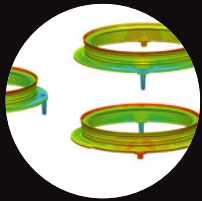

Allows easy evaluation of part quality ...

... as it not only calculates curing, but also degradation effects.



Reduces material waste ...

... with an effortless comparison of different gating systems (cold runner calculation, cascade injection, etc.) for serial production.

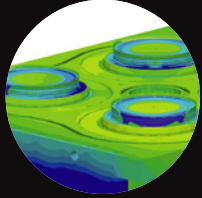

Optimizes processes ...

... because all process times are taken into account over several cycles – even potential time-outs between cycles.

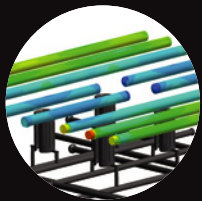

Takes care of the optimum thermal layout ...

... by testing different tempering concepts comfortably and fast before the mold is built – even of innovative concepts for serial production.

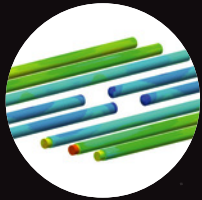

Defines energy efficient processes ...

... by an easy dimensioning of electrical heating systems, including the determination of necessary power and optimum control parameters.